

GAS TOOL PARTS LIST

■ GAS STRIP NAILER Model NR 90GC

2006 · 9 · 15

(E3)

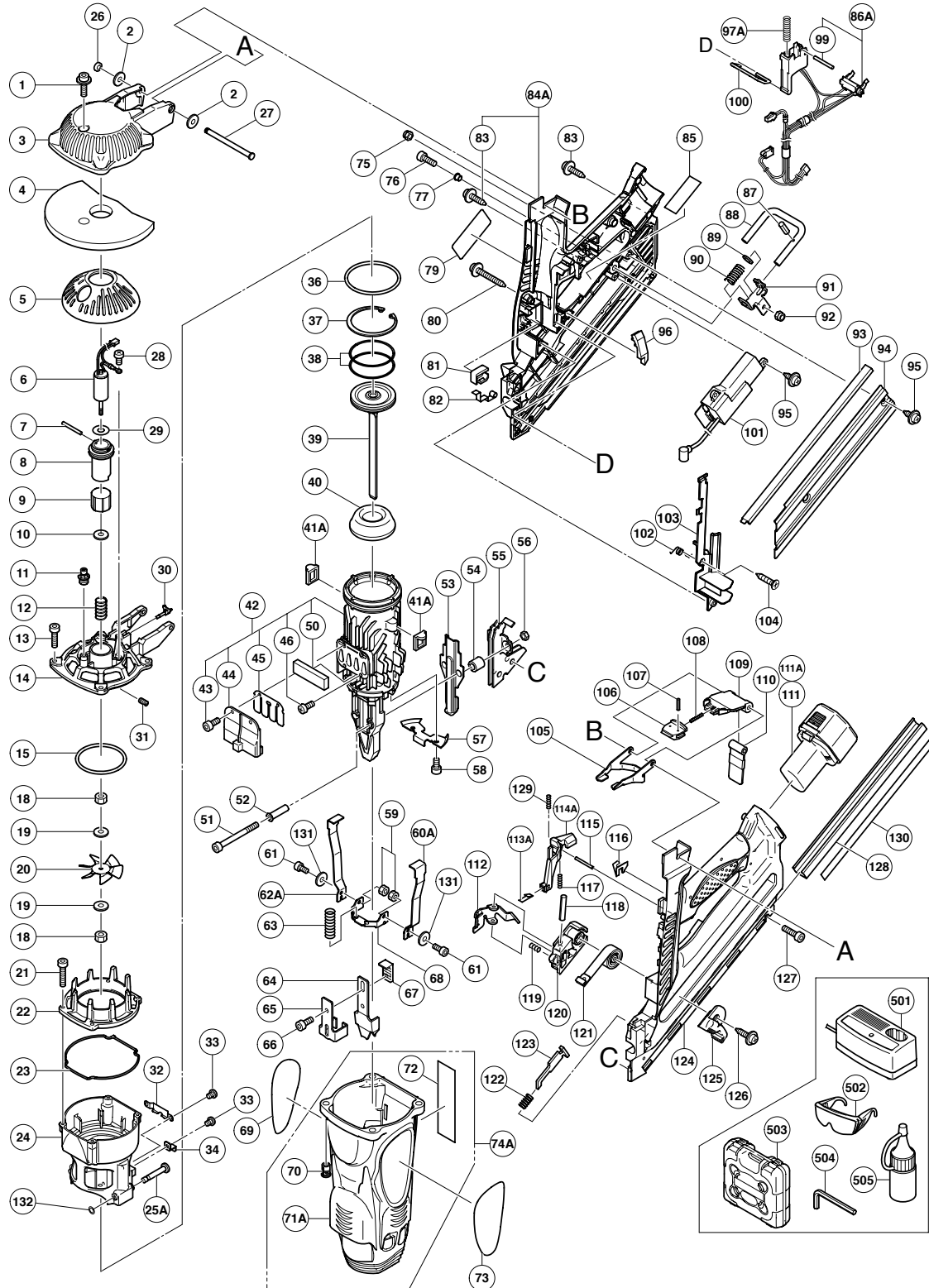

PARTS

NR 90GC

ITEM NO.	CODE NO.	DESCRIPTION	NO. USED	REMARKS
1	996-399	HEX. SOCKET HD. BOLT (W/FLANGE) M5X12	1	
2	949-424	WASHER M5 (10 PCS.)	2	
3	885-353	TOP COVER	1	
4	885-274	FILTER	1	
5	885-275	FILTER COVER	1	
6	885-309	MOTOR	1	
7	885-318	ROLL PIN D2.5X25	1	
8	885-310	MOTOR MOUNT	1	
9	885-314	MOUNT SLEEVE	1	
10	885-320	SHAFT WASHER	1	
11	885-333	SPARK PLUG (A)	1	
12	885-319	MOTOR SPRING	1	
13	949-757	HEX. SOCKET HD. BOLT M5X20 (10 PCS.)	4	
14	885-308	CYLINDER HEAD	1	
15	885-316	O-RING (I.D 59. 92)	1	
18	949-554	NUT M4 (10 PCS.)	2	
19	949-423	WASHER M4 (10 PCS.)	2	
20	885-311	FAN	1	
21	949-754	HEX. SOCKET HD. BOLT M4X16 (10 PCS.)	4	
22	885-294	CHAMBER HEAD	1	
23	885-295	GASKET (A)	1	
24	885-296	CHAMBER	1	
25A	885-921	PIN	2	
26	880-319	SHAFT RING	1	
27	885-277	SHAFT	1	
28	949-214	MACHINE SCREW M4X6 (10 PCS.)	1	
29	885-313	RUBBER WASHER	1	
30	885-317	ADAPTER	1	
31	961-681	HEX. SOCKET SET SCREW M4X5	2	
32	885-297	CHAMBER LOCK PLATE	1	
33	949-214	MACHINE SCREW M4X6 (10 PCS.)	3	
34	885-306	SWITCH PLATE	1	
36	885-283	O-RING (I.D. 66.27)	1	
37	885-285	RETAINING RING	1	
38	885-286	PISTON RING	2	
39	885-291	PISTON	1	
40	885-289	PISTON BUMPER	1	
* 41A	885-790	CHAMBER STOP RUBBER (A)	2	
* 41A	885-284	CHAMBER STOP RUBBER	2	FOR USA, CAN
42	885-361	CYLINDER ASS'Y	1	INCLUD. 43-46, 50
43	949-812	HEX. SOCKET HD. BOLT M4X10 (10 PCS.)	2	
44	885-287	BUFFER COVER	1	
45	885-290	LEAD VALVE	1	
46	949-214	MACHINE SCREW M4X6 (10 PCS.)	2	
50	885-288	MUFFLER	1	
51	949-897	HEX. SOCKET HD. BOLT M5X50 (10 PCS.)	2	
52	885-269	NOSE SLEEVE	2	
53	885-355	BLADE GUIDE	1	
54	885-270	PLATE SLEEVE	2	
55	885-326	SIDE PLATE	1	
56	945-255	U-NUT M5	2	

PARTS

NR 90GC

ITEM NO.	CODE NO.	DESCRIPTION	NO. USED	REMARKS
57	885-299	CYLINDER PLATE	1	
58	980-046	SEAL LOCK HEX. SOCKET HD. BOLT M5X10	2	
59	956-329	U-NUT M4	2	
60A	885-787	PUSHING LEVER ARM (A)	1	
61	878-356	SEAL LOCK HEX. SOCKET HD. BOLT M4X10	2	
62A	885-789	PUSHING LEVER ARM (B)	1	
63	885-305	PUSHING LEVER SPRING	2	
64	885-271	PUSHING LEVER	1	
65	885-273	PUSHING STOPPER	1	
66	949-819	HEX. SOCKET HD. BOLT M5X10 (10 PCS.)	1	
67	885-272	ADJUSTER BUSH (S)	1	
68	885-301	PUSHING LEVER CONNECTOR	1	
69		NAME PLATE	1	
70	885-304	SCREW M5	4	
71A	885-822	HOUSING	1	
72	885-307	INSULATOR SHEET	1	
73		HITACHI LABEL	1	
74A	885-823	HOUSING ASS'Y	1	INCLUD. 70-72
75	876-465	NYLON NUT M4	1	
76	949-820	HEX. SOCKET HD. BOLT M5X15 (10 PCS.)	1	
77	878-164	SLEEVE	1	
79		WARNING LABEL	1	
80	301-815	TAPPING SCREW (W/FLANGE) D4X45	1	
81	885-334	SWITCH MOUNT	1	
82	885-347	SWITCH ARM	1	
83	302-086	TAPPING SCREW (W/FLANGE) D4X20 (BLACK)	5	
84A	886-034	HANDLE (B) ASS'Y	1	INCLUD. 83
85		CAUTION PLATE	1	
86A	885-798	TRIGGER INTERNAL WIRE (A) SET	1	INCLUD. 99
87	949-900	ROLL PIN D3X14 (10 PCS.)	1	
88	885-343	HOOK	1	
89	956-161	WASHER (B)	1	
90	885-345	SPRING D12	1	
91	885-344	BRACKET	1	
92	877-371	NYLON NUT M5	1	
93	885-341	NAIL RAIL	1	
94	885-342	MAGAZINE PLATE	1	
95	309-933	TAPPING SCREW (W/FLANGE) D4X14 (BLACK)	3	
96	885-338	PRISM	1	
97A	885-828	TRIGGER SPRING (A)	1	
99	949-551	ROLL PIN D2.5X10 (10 PCS.)	1	
100	885-340	CHAMBER LOCK BAR	1	
* 101	885-331	CONTROLLER	1	
* 101	885-595	CONTROLLER	1	FOR USA, CAN
102	885-337	LOCK BAR SPRING	1	
103	885-339	WIRING COVER	1	
104	885-346	FLAT HD. TAPPING SCREW D4	1	
105	885-276	CELL LEVER	1	
106	885-280	LATCH	1	
107	949-859	ROLL PIN D2X8 (10 PCS.)	2	
108	885-281	SPRING D3.6	1	

PARTS

NR 90GC

ITEM NO.	CODE NO.	DESCRIPTION	NO. USED	REMARKS
109	885-352	CELL COVER	1	
110	885-279	CELL RUBBER	1	
* 111	324-148	BATTERY EB 714S (EUROPE, AUS, NZL)	1	
* 111A	325-292	BATTERY EB 714S (USA, CAN)	1	FOR USA, CAN
112	885-323	NAIL FEEDER (A)	1	
113A	885-824	TENSION PLATE (A)	1	
114A	885-825	SWITCH LEVER (B)	1	
115	885-349	PIN D2.5	1	
116	885-329	LEVER STOPPER	1	
117	885-350	SPRING D2.95	1	
118	949-506	ROLL PIN D4X28 (10 PCS.)	1	
119	883-687	SPRING	1	
120	885-324	NAIL FEEDER (B)	1	
121	885-325	RIBBON SPRING	1	
122	885-328	SPRING D8	1	
123	885-327	PUSHING LEVER STOPPER	1	
124	885-321	HANDLE (A)	1	
125	885-322	FEEDER KNOB	1	
126	302-089	TAPPING SCREW (W/FLANGE) D5X20 (BLACK)	1	
127	880-003	HEX. SOCKET HD. BOLT M4X18	1	
128	885-354	MAGAZINE GUARD	1	
129	885-518	SPRING	1	
* 130		LABEL (A)	1	EXCEPT FOR USA, CAN
131	949-453	SPRING WASHER M4 (10 PCS.)	2	
132	878-607	PLUNGER O-RING	2	

STANDARD ACCESSORIES

ITEM NO.	CODE NO.	DESCRIPTION	NO. USED	REMARKS
501		CHARGER (MODEL UC 7SD)	1	
502	875-769	SAFETY GLASSES	1	
503	885-360	CASE	1	
504	944-458	HEX. BAR WRENCH 4MM	1	
* 505	886-036	LUBRICANT OILER (B)	1	FOR EUROPE

OPTIONAL ACCESSORIES

ITEM NO.	CODE NO.	DESCRIPTION	NO. USED	REMARKS
* 601	885-246	LUBRICANT OILER (A)	1	
* 601	885-546	LUBRICANT OILER (A)	1	FOR USA, CAN
602	317-918	GREASE(ATTOLUB NO. 2) 500G	1	
603	885-788	RUBBER NOSE ASS'Y	1	INCLUD. 604
604	885-791	RUBBER NOSE	1	