

HITACHI

LIST NO. 1087

PNEUMATIC TOOL PARTS LIST

■ STRIP NAILER
Model NR 90AC

1998 · 1 · 10
(E1)

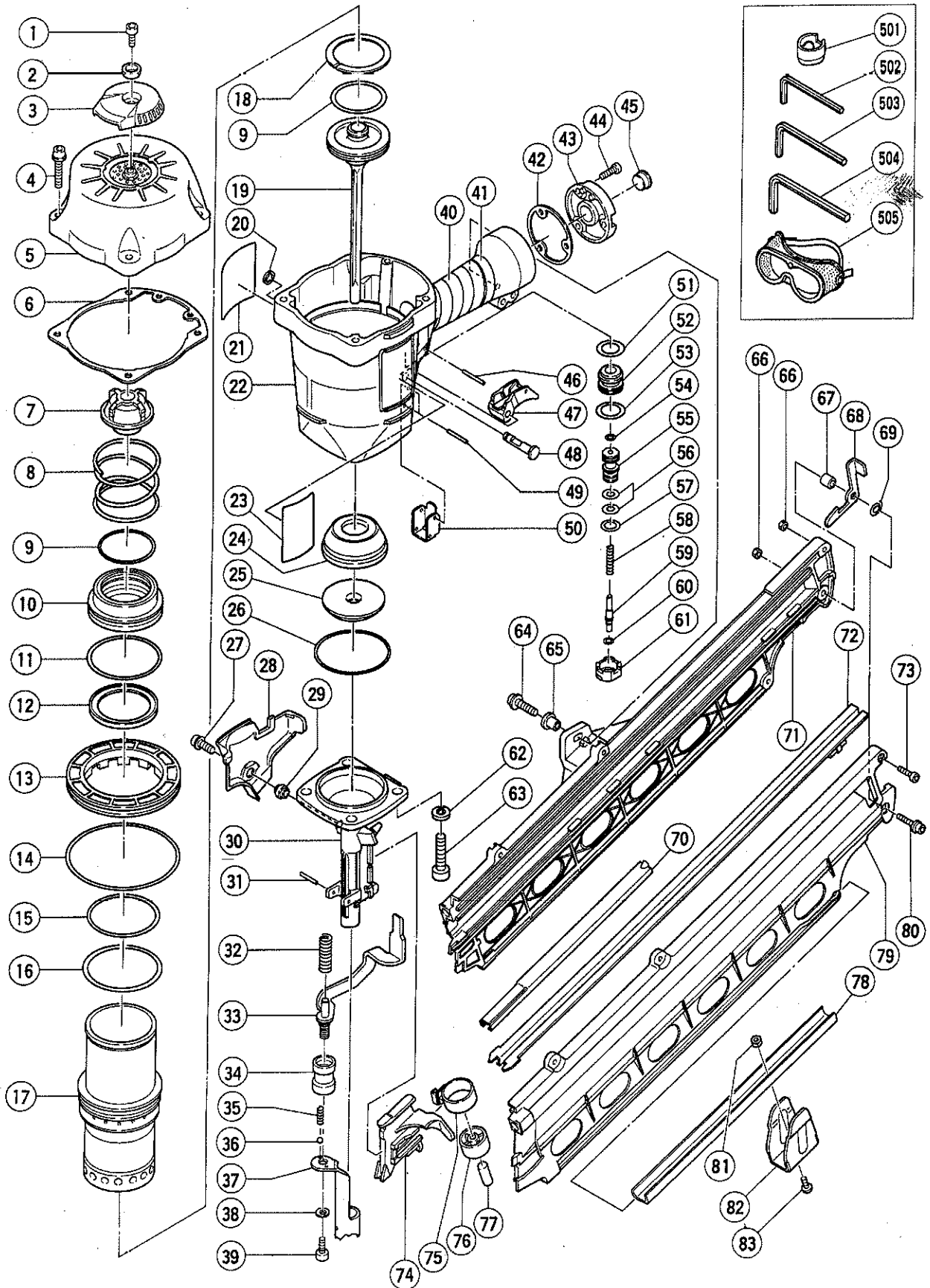

PARTS

NR 90AC

ITEM NO.	CODE NO.	DESCRIPTION	NO. USED	REMARKS
1	949-755	HEX. SOCKET HD. BOLT M6X16 (10 PCS.)	1	
2	880-515	PLATE	1	
3	880-514	TOP COVER	1	
4	301-597	HEX. SOCKET HD. BOLT (W/FLANGE) M6X35	4	
5	881-946	EXHAUST COVER	1	
6	881-940	GASKET (A)	1	
7	881-945	EXHAUST VALVE RUBBER	1	
8	881-944	HEAD VALVE SPRING	1	
9	877-124	CYLINDER O - RING (B)	2	
10	881-942	HEAD VALVE	1	
11	877-315	CYLINDER O - RING (I.D 63.9)	1	
12	881-943	HEAD VALVE RUBBER	1	
13	881-941	CYLINDER PLATE	1	
14	878-907	O - RING (S - 95)	1	
15	878-376	O - RING (I.D 59.6/W2.4)	1	
16	881-972	O - RING	1	
17	881-939	CYLINDER	1	
18	881-930	PISTON RING	1	
19	881-953	PISTON	1	
20	955-479	RETAINING RING (E - TYPE) FOR D6 SHAFT	1	
21	878-184	WARNING LABEL	1	
22	881-938	BODY ASS'Y	1	INCLUD.40,41
23		NAME PLATE	1	
24	881-966	PISTON BAMPER (A)	1	
25	881-967	PISTON BAMPER (B)	1	
26	877-312	CYLINDER O - RING (I.D 63.1)	1	
27	881-969	NYLOCK BOLT (W/FLANGE) M6X20	1	
28	881-935	GUARD	1	
29	881-936	COLLAR (B)	1	
30	881-932	NOSE	1	
31	949-864	ROLL PIN D3X22 (10 PCS.)	1	
32	881-954	SPRING	1	
33	881-934	PUSH LEVER (B)	1	
34	880-082	ADJUSTER	1	
35	982-454	SPRING (C)	2	
36	959-148	STEEL BALL D3.175 (10 PCS.)	2	
37	881-933	PUSH LEVER (A)	1	
38	880-081	WASHER	1	
39	949-657	HEX. SOCKET HD. BOLT M6X12 (10 PCS.)	1	
40	881-768	GRIP TAPE (A)	1	
41	880-407	TAPE	2	
42	881-769	GASKET (B)	1	
43	881-949	CAP	1	
44	949-821	HEX. SOCKET HD. BOLT M5X18 (10 PCS.)	3	
45	872-035	DUST CAP	1	
46	949-864	ROLL PIN D3X22 (10 PCS.)	1	
47	880-674	TRIGGER (A)	1	
48	881-952	TRIGGER PIN	1	
49	949-865	ROLL PIN D3X28 (10 PCS.)	2	
50	880-361	PUSHING LEVER GUIDE	1	
51	877-699	HEAD VALVE O - RING (I.D 16.8)	1	

*: ALTERNATIVE PARTS

PARTS

NR 90AC

ITEM NO.	CODE NO.	DESCRIPTION	NO. USED	REMARKS
52	878-881	VALVE BUSHING (B)	1	
53	878-885	O - RING (S - 18)	1	
54	981-317	O - RING (S - 4)	1	
55	880-672	VALVE PISTON (B)	1	
56	878-925	O - RING (I.D 8.8)	2	
57	878-887	O - RING (I.D 11)	1	
58	878-884	PLUNGER SPRING	1	
59	880-673	PLUNGER (A)	1	
60	878-888	O - RING (I.D 1.8)	1	
61	880-671	VALVE BUSHING (A)	1	
62	949-457	SPRING WASHER M8 (10 PCS.)	4	
63	306-183	NYLOCK HEX. SOCKET HD. BOLT M8X35	4	
64	949-670	HEX. SOCKET HD. BOLT M6X22 (10 PCS.)	1	
65	881-937	COLLAR (C)	1	
66	876-465	NYLON NUT M4	5	
67	881-965	COLLOR (A)	1	
68	881-963	STOP LEVER	1	
69	881-964	STOPPER SPRING	1	
70	881-957	NAIL RAIL	1	
71	881-956	MAGAZINE (B)	1	
72	881-958	GUIDE RAIL	1	
73	949-754	HEX. SOCKET HD. BOLT M4X16 (10 PCS.)	4	
74	881-960	NAIL FEEDER	1	
75	881-961	RIBBON SPRING	1	
76	881-962	BUSHING	1	
77	878-418	NEEDLE ROLLER	1	
78	881-959	MAGAZINE GUARD	1	
79	881-955	MAGAZINE (A)	1	
80	963-398	HEX. SOCKET HD. BOLT (W/FLANGE) M4X20	1	
81	949-566	LOCK NUT M5 (10 PCS.)	1	
82	881-970	PLATE	1	
83	881-971	HEX.SOCKET BUTTON BOLT M5X6.5	1	

STANDARD ACCESSORIES

ITEM NO.	CODE NO.	DESCRIPTION	NO. USED	REMARKS
501	881-968	NOSE CAP	1	
502	944-458	HEX. BAR WRENCH 4MM	1	
503	944-459	HEX. BAR WRENCH 5MM	1	
504	872-422	HEX. BAR WRENCH 6MM	1	
505	875-769	EYE PROTECTOR	1	

* : ALTERNATIVE PARTS

